



Q402
User Guide

Contents

The Android Advantage	2
Read Me First	2
Panic Button	2
Understand Your Phone	3
Insert SIM and Memory Card	4
Charge the Device	6
Google Account.....	6
Play Store	7
Notifications	7
Phone Security	9
Battery Saver Mode	10
Settings and Networks	11
Pair With Bluetooth Devices	12
Airplane Mode	13
Google Maps.....	13
Safety Precautions	14
Taking Care of your device	15
Device Recommendations	16
Temperature and Humidity	16
Recycle your Phone	16
Disclaimer	17
Copyright	17

The Android Advantage

Micromax Q402 comes with Android Marshmallow, which provides you a host of advanced and desirable features to give you a whole new Android experience.

Read Me First

- Please read all safety precautions and this user guide carefully before using your device to ensure safe and proper use.
- The descriptions in this user guide are based on the default settings of your device.
- Available features and additional services may vary by device, software, or service provider.
- Applications and their functions may vary based on the country, region, software or hardware specifications. Micromax is not liable for performance issues caused by third-party applications.

Panic Button

Your device supports the Panic button functionality which lets you call emergency services for immediate assistance in case of an emergency situation.

Press the Power key 3 times in quick succession and your device initiates a call to the emergency number 112, which will direct the call to concerned departments for help.

You can invoke the Panic button even when the device is locked.

Understand Your Phone

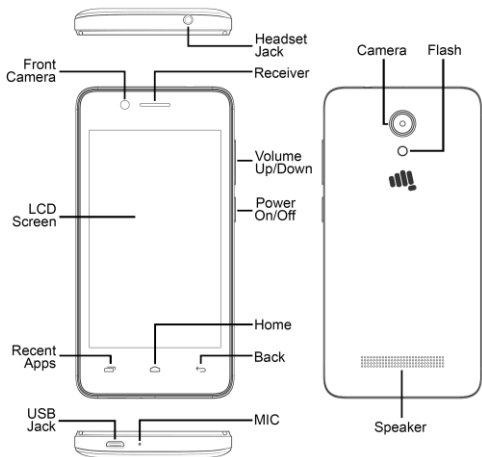

Insert SIM and Memory Card

1. Switch off your phone and remove the rear cover and battery as shown:

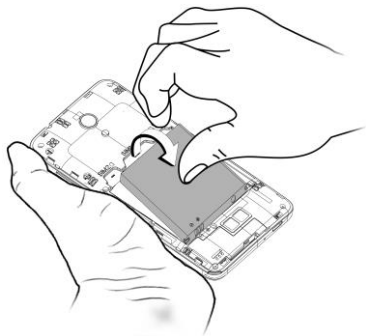
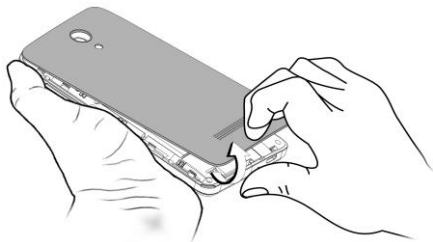

2. Insert SIM card(s) in the SIM slot(s), as shown:

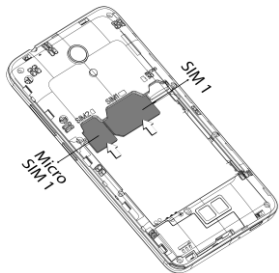

3. Insert the memory card correctly, as shown:



4. Place back the battery and rear cover.



Please keep the SIM card out of the reach of children.

Charge the Device

Before first use, we recommend you to fully charge the device.

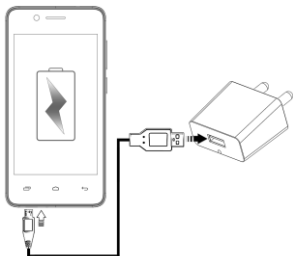

Use only Micromax chargers and cables. Other chargers or cables may damage your device. This will invalidate your phone warranty.

Google Account

Your Google Account lets you take full advantage of applications and services offered by Google Play Store. Configure your Google account on this handset to get access to your Gmail, Google Play Store, Google Maps, and much more.



Internet connection is required to set up Google account.

You can configure your Google account from **Settings** → **Accounts** → **Add**

account → Google.



If you do not have an existing Google account, you may create one from the account configuring step.

Play Store

After you have configured your Google account, you can access Play Store by tapping  icon and choose to download from unlimited entertainment sources, applications, games, movies, and books.

To view and manage the list of all inbuilt, downloaded, and running applications, go to **Settings → Apps**.

Notifications

Notifications inform you of new messages and events as and when they appear on the device.

Open Notification panel

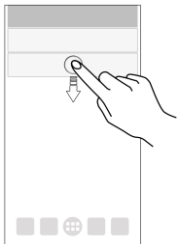

Close Notification panel

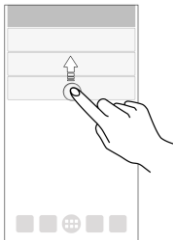

Clear all Notifications

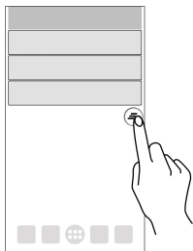

Open Quick Settings

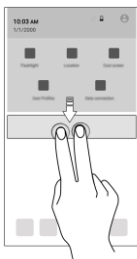

Quick Settings allow access to basic phone features such as Airplane Mode, Wi-Fi, Display Brightness, and many more.

Phone Security

You can unlock your phone using a variety of methods.



The default unlock method is **Swipe**. To unlock the screen, just swipe up on the lock screen.

To set other unlocking methods, go to **Settings** → **Security** → **Screen lock**.

Pattern

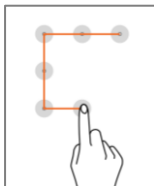

Draw your pattern to unlock! You can set your own pattern by connecting the dots to prevent your phone from unauthorized access.

PIN



Enter your PIN to unlock your phone! You can set a PIN as your screen password.

Password



Enter your password to unlock! You can set your desired password as your screen password.

Battery Saver Mode

Your phone comes with a Battery Saver Mode that:

Saves power significantly by running only the essential apps while turning off background data.

Restricts the background data for apps like Gmail, Twitter, Facebook, etc. and limits the phone's performance to extend the battery life.

Automatically switches off when the phone is connected to a charger.

To enable Battery Saver mode:

1. Go to **Settings** → **Battery**.
2. Tap  icon and select **Battery saver**.

Settings and Networks

Your phone can connect to various networks and devices. You can also transfer files to/from your PC through the data cable.

Connect to the Internet

Go to **Settings** → **SIM cards** and enable **Cellular data** on your preferred SIM.

You might also need to configure the access point name for the data connection to work.



By default, the access point name gets configured once you insert the SIM, Or, your network provider sends the access point name settings via SMS. You may need to install these settings. If the access point names are not listed by default, please contact your network provider for the same.

You can configure the access point name from

Settings → **More** → **Cellular networks** → **Access Point Names** and select from the list.

Tethering & Portability

You can use your device as a modem and connect your PC or laptop to the Internet, when required.

Go to **Settings** → **More** → **Tethering & portable hotspot**

USB Tethering

1. Connect your phone with your PC/Laptop via USB cable.
2. Select the **USB tethering** option.
3. Select your phone network as the network connection in your PC/laptop and get access to the Internet.

Wi-Fi Hotspot

1. Tap and enable **Portable Wi-Fi hotspot** option in your phone.
2. Enable Wi-Fi on the other Wi-Fi enabled PC/laptop/handset, choose your phone as a Wi-Fi network to connect with it.
3. View and configure Wi-Fi hotspot settings from **Wi-Fi hotspot settings** → **Set up Wi-Fi hotspot**



Your mobile operator will charge you based on your data usage.

Bluetooth Tethering

1. Pair your phone with a Bluetooth enabled PC/laptop via Bluetooth pairing option.
2. Select the **Bluetooth tethering** option in your phone.
3. On the paired PC/laptop, select the Bluetooth device (your phone) and choose to connect to the Internet.

Pair With Bluetooth Devices

Go to **Settings** → **Bluetooth**

1. If Bluetooth is off, turn it on. Your phone scans and displays the Bluetooth devices in range.
2. Tap the ID of the other device in the list to pair with it.
3. You may be prompted to confirm passkey on one of the devices. The passkey may display on one of the devices.
4. Tap **Pair** to confirm the passkey and pair the devices. On successful pairing, your phone connects to the device.



If the device you want to pair with is not in the list, make sure the Bluetooth on that device is turned on, then tap  and select **Refresh** to search again.

Airplane Mode

Airplane Mode allows you to disable all Mobile networks, Wi-Fi, and Bluetooth connections. To activate the airplane mode, open **Quick settings** and select **Airplane mode**.

Google Maps

Google Maps is a web-based service offered by Google Inc. which offers you access to various map-based services. You can view various streets, landmarks and can even plan your routes with the help of Google Maps.

Settings required for Google Maps access include:

1. Enable location access from **Settings** → **Location**.
2. Tap  to start using Google Maps.



Internet connection is required for using Google Maps. When you use the map, you use your Internet connection to transfer data to and from your phone.



Google Maps application may not be available in every street, country or region.



Micromax does not guarantee the accuracy of any directional services.

Operating Temperature Specifications

Maximum device operating temperature	45°C
Device operating temperature range	-10 to 45°C

Safety Precautions



Switch off your device in any area with potential explosive atmosphere such as refueling stations, fuel depots, chemical plants or places where blasting operation is in progress. Sparks arising out of radio frequency may cause fire or explosion. Remember to comply with legal requirements and local restrictions when using the phone.



Your Phone's radiowaves may interfere with medical devices. Preferably maintain a distance of 15.3 cm (6 inches) between a wireless device and implanted medical devices such as pacemaker or cardioverter defibrillator. Switch off your device when regulations require you to do so.



Always keep the phone and accessories out of reach of small children. Small parts such as the SIM card can be dismantled and swallowed by small children.



Do not place the phone near electromagnetic data carriers such as credit/Debit cards. Information stored on them could be lost.



Permanent damage to hearing may occur if you use earphones at high volume for prolonged periods. Set your volume to a safe level.



The mains voltage (V) specified on the power supply unit must not be exceeded to prevent damage to the charging device. The power supply must be plugged into an easily accessible AC power socket when charging the device.



You may only open the phone to replace the SIM card(s). All other changes to this device are strictly prohibited and will invalidate the warranty.



The phone may cause interference in the vicinity of TV sets, radios and PCs.



Do not use the phone while driving. Please put the phone safely in the phone stand. Do not put it onto any spot from which it may fall down during collision or emergency braking.



Flight is influenced by interference caused by the phone. It is not advised to switch on a phone during flight.



Please repair the device at Micromax authorized service center only. Repairing the device by yourself invalidates the warranty rules.

Taking Care of your device

Your device is a product of superior design and craftsmanship and should be handled with care in the following ways:

- Keep the device dry. Precipitation, humidity, and all types of liquids can rust the electronic circuits. If your device gets wet, wipe it with a dry cloth and take it to an authorized service center.
- Do not store the device in high or cold temperature. Extreme temperatures can shorten the life of electronic devices and damage batteries.
- Do not use or store the device in dusty, dirty areas. Its moving parts and electronic components can get damaged.
- Do not attempt to open the device other than as instructed in this guide.
- Do not drop, knock, shake or bend the device. Rough handling can break internal circuit boards and fine mechanics.
- Do not use harsh chemicals, cleaning solvents, or strong detergents to clean the device. Only use a soft, clean, dry cloth to clean the surface of the device.

- Do not store or bring your device near magnetic fields for extended period of time.

Device Recommendations

- We recommend you to charge the device at room temperature range.
- Batteries have life cycles. After a full charge, if the power reserve of the device tends to deplete inordinately faster than usual, the battery life is at an end.
- Use only Micromax chargers and cables. Micromax will not be held responsible for user's safety when using incompatible accessories or supplies.

Temperature and Humidity

The device is designed for use within a temperature range of $-20^{\circ}\text{C} \pm 5$ to $45^{\circ}\text{C} \pm 5$, storage within the temperature range of $-30^{\circ}\text{C} \pm 5$ to $65^{\circ}\text{C} \pm 5$. In case of violation of these temperature conditions, the device can be damaged and battery life can be reduced.

The recommended humidity for maintaining the device is in the range 50 to 55%.

Do not expose your device to extreme temperatures or humidity.

Note: Micromax will not bear any responsibility for any in compliance with the above mentioned guidelines or improper usage of the mobile phone.

Recycle your Phone



The WEEE logo (shown at the left) appears on the product (handset, and charger) to indicate that this product must not be disposed of or dumped with your other household wastes. You are liable to dispose of all your electronic or electrical waste equipment by relocating over to the specified collection point for recycling of such hazardous waste.

Collection and proper recovery of your electronic waste equipment at the time of disposal will allow us to help preserve the environment. Recycling of the electronic waste equipment will ensure safety of human health and environment. For more information on best practices for disposal of electronic and electrical waste, please visit to our web site:

www.micromaxinfo.com/weee.php.

Disclaimer

- The colors, specifications, functions and graphics shown/mentioned in the user manual may differ from the actual product. In such a case, the latter shall govern. Images shown are for representation purpose only. Specifications are subject to change without prior notice. Micromax keeps the right to modify the content in this user guide without prior notice.
- Upon first use of your device, your device will send information related to your mobile, IMEI numbers, location details and other software details through SMS* automatically. This information may be used as further specified in Micromax privacy policy**.
- Talk and standby times are affected by network preferences, type of SIM cards, connected accessories and individual usage patterns. Services and some features may be dependent on the network, service/content providers, SIM cards compatibility of the devices used and the content formats supported.
- Other product logos and company names mentioned herein may be trademarks or trade names of their respective owners.
- Available storage memory may vary based on the phone software.

*Operator tariff shall be applicable for SMS.

**Micromax privacy policy is available at www.micromaxinfo.com.

Copyright

All rights reserved. Reproduction, transfer, distribution or storage of part or all of the contents in this document in any form without the prior written permission of Micromax is strictly prohibited.

SAR Information

SAR Compliance

- Your device is designed not to exceed the limits of emission of radio waves recommended by international guidelines.
- SAR (Specific Absorption Rate) is the measurement of body-absorbed RF quantity when the device is in use. SAR value is ascertained according to the highest RF level generated during laboratory tests.
- The SAR value of the device may depend on factors such as proximity to the network tower, or use of accessories.
- The SAR value of the device at the head and body are 1.12 W/kg and 1.50 W/kg respectively averaged over 1 gm of human tissue.

SAR Recommendations

- Use a wireless hands-free system (head phone, head set) with a low power Bluetooth emitter.
- Keep your calls short and use SMS whenever more convenient. This advice applies especially to children, adolescents and pregnant women.
- Prefer to use your handset when the signal quality is good.
- People having active medical implants should preferably keep the handset at least 15 cm away from the implant.
- Maintain a preferable distance of 15 mm from the device.

The FCC Advice

Many people mistakenly assume that using a cell phone with a lower reported SAR value necessarily decreases a user's exposure to RF emissions, or is somehow "safer" than using a cell phone with a high SAR value. While SAR values are an important tool in judging the maximum possible exposure to RF energy from a particular model of cell phone, a single SAR value does not provide sufficient information about the amount of RF exposure under typical usage conditions to reliably compare individual handset models.

World Health Organization (WHO) Advice

Organizations such as the World Health Organization and the US Food and Drug Administration have stated that if people are concerned and want to reduce their exposure they could use a hands-free device to keep the handset away from the head and body during phone calls, or reduce the amount of time spent on the phone.

For Product Support:

Helpline Number

: 18605008286

Working Hours

: Monday to Saturday (Except National
& Public Holidays)
10 AM to 6:30 PM

Email Support (India)

: info@micromaxinfo.com

Email Support (International Market)

: ccdesk_global@micromaxinfo.com



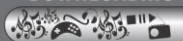

Website

: www.micromaxinfo.com

DOWNLOADING



mimicromax    com

-  **Games:** Premium & Coolest Gaming Titles. Choose from Action, Racing, Cricket & More.
-  **Videos:** Bollywood & Fun Videos. Pick your favourite from Comedy to Action.
-  **Music:** MP3 & Ringtones. Perfect mix of Latest & Evergreen.
-  **Wallpapers:** Animations & Wallpapers. Celebrities, Devotional, Nature & More.

Activate Internet connection and tap  icon or visit mimicromax.com from your mobile browser now.

* Operator data charges may apply.

Warranty Statement

Micromax congratulates and thanks you for showing confidence in Micromax products and becoming our valued customer. To ensure a delightful product experience, Micromax recommends reading the User Guide carefully and contacting our customer care. For further information, please log on to our website www.micromaxinfo.com, Email us, or contact our helpline numbers listed below.

Country	Helpline	Email
India	1860-500-8286	info@micromaxinfo.com
Russia	8800 2509897	ccdesk.global@micromaxinfo.com
Sri Lanka	0117-271271	
Bangladesh	880-1673556699	
Nepal	977-9721604522	

Working Hours : Monday to Saturday (Except National & Public Holidays)
10 AM to 6:30 PM
Website : www.micromaxinfo.com

Micromax Informatics Ltd. (hereinafter called "Micromax") warrants the Product to be free from defects in materials and workmanship, arising under normal use from the date of original purchase when brand new.

This Warranty is subject to the following terms and conditions:

1. Micromax provides 1 year warranty on the transceiver and 6 months warranty for the battery and accessories included in the sales pack, applicable from the date of purchase.
2. The warranty is confined to the original purchaser of the product only and is not transferable.
3. It is the responsibility of the customer to visit the Micromax authorized service center for required services.
4. Warranty will be applicable only after inspection of the device and clearance of condition by authorized service center personnel.
5. Customer should kindly take a backup of all the personal contents and remove any confidential, proprietary, or personal information from the device before handing over the handset for service.
6. The company shall not be liable for problems arising out of any 3rd party software being used by the customer.
7. Repairs under warranty period shall be carried out by the company authorized

personnel only. For further details, please visit our website:
www.micromaxinfo.com or the centralized helpline.

8. Warranty will not be applicable under the following circumstances:
 - a) Damage due to any liquid, Mechanical stress, impact, high voltage, negligence, misuse, accident or natural disasters
 - b) Use of charger or battery not included in the Gift Box of this device.
 - c) Warranty also does not cover cracks in device display or device outer housing.
 - d) The handset IMEI number/serial no., the accessories date code, water indicator or the warranty seal has been removed, erased, defaced, altered or is illegible.
 - e) The defect was caused by defective function of the service provider cellular network, unauthorized software or other system.

In the above cases, repairs will be done subject to availability of parts and on a chargeable basis only.

9. The company's obligation under this warranty shall be limited to repair or providing replacement of part/s only. If the company is not able to repair the handset covered under warranty then it can be replaced by same model of the handset.
10. Wherever local service presence* is there, standard warranty terms as specified will be honored.
11. Micromax reserves the right to charge a service fee for repair/ service of any nature that is not covered by this warranty.
12. All warranty information, products and specifications are subject to change without prior notice.

Valid for devices sold outside India:

13. Service will not be applicable without the warranty card and valid proof of purchase/Invoice/Bill
14. For limited warranty to be valid, all information on the limited warranty card has to be complete including the stamp and C- sticker (on the proof of purchase/Invoice/Bill) from the authorized distributor.

*Micromax reserves the right to withdraw these services without any prior notice.

MICROMAX (hereinafter referred to as "the company") guarantees to the purchaser that this product carries a warranty for the period mentioned above, commencing from the date of purchase. The company will repair free of charge any part or parts of the product, if the defect is due to the faulty material or workmanship.

CUSTOMER COPY

Model Name _____

Product Serial No. _____ IMEI No./MEID No. (1) _____

Date of Purchase (2) _____

dd

mm

yy

Customer's Details

Important: Paste C-Sticker on purchase Invoice/Bill

Name _____

Address in full _____

Telephone No. _____

Dealer Name & Address _____

Dealer's Signature with rubber stamp

Customer's Signature & Date

(I accept the terms & conditions of warranty)



DEALER COPY

Model Name _____

Product Serial No. _____ IMEI No./MEID No. (1) _____

Date of Purchase (2) _____

dd

mm

yy

Customer's Details

Name _____

Address in full _____

Telephone No. _____

Dealer Name & Address _____

Dealer's Signature with rubber stamp

Customer's Signature & Date

(I accept the terms & conditions of warranty)